

# USB AND IEEE 1394

UNIVERSAL SERIAL BUS & FIREWIRE CONNECTORS



## SPECIFICATIONS

### Material:

**Shell:** Phosphor Bronze, tin-plated  
**Insulator:** PBT, glass reinforced thermoplastic, rated UL 94V-0  
**Insulator color:** Black  
**Contacts:** Phosphor Bronze

### Plating:

5 µin gold on contact area over 50 µin nickel underplate  
 100 µin tin-lead on solder tails

### Electrical:

**Operation voltage:** 500 V DC  
**Current rating:** 1 Amp  
**Contact resistance:** 15 mΩ  
**Insulation resistance:** 1000 MΩ  
**Dielectric withstanding voltage:** 1000V

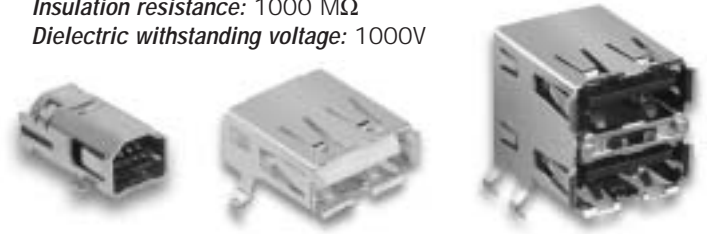

## ORDERING INFORMATION

choose one from each category as shown in sample below

USB Series	A Type	1 Ports	Options (add as suffix to part number)
<b>USB</b> - Universal Serial Bus right angle mount <b>USM</b> - Mini Universal Serial Bus <b>FWC</b> - Firewire connector	<b>A</b> - USB Type A <b>A4</b> - Mini USB, A, 4P <b>B</b> - USB Type B <b>B4</b> - Mini USB, B, 4P <b>B5</b> - Mini USB, B, 5P <b>C</b> - IEEE 1394 Firewire	<b>1</b> - Single Port <b>2</b> - Dual Port	<b>SMT</b> - Surface mount leads <b>WT</b> - White color insulator <b>NF</b> - No flange <b>UP</b> - Right Angle, Upright PCB Mount (IEEE 1394 only) <b>ST</b> - Vertical Mount

### USM-A4-1-SMT(4P) MINI-USB-A4 SMT

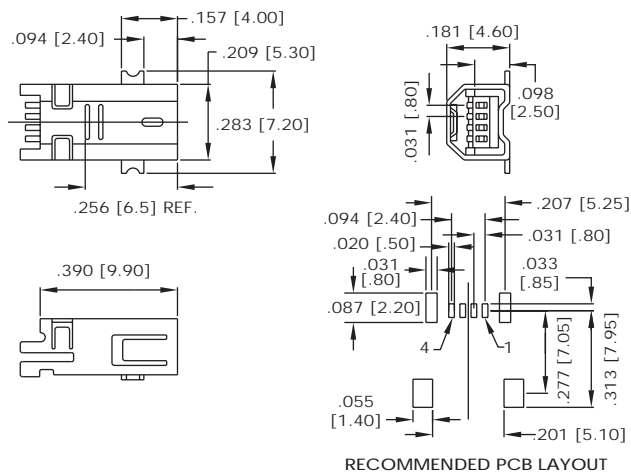

### USM-B5-1-SMT(5P) MINI-USB-B5 SMT

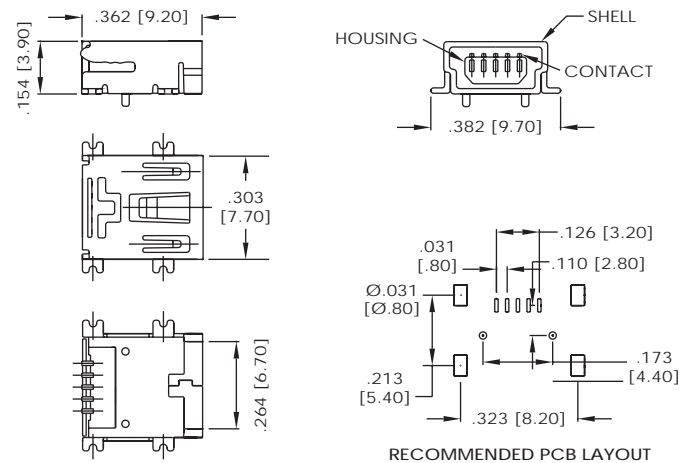

### USM-B4-1-SMT(4P) MINI-USB-B4 SMT

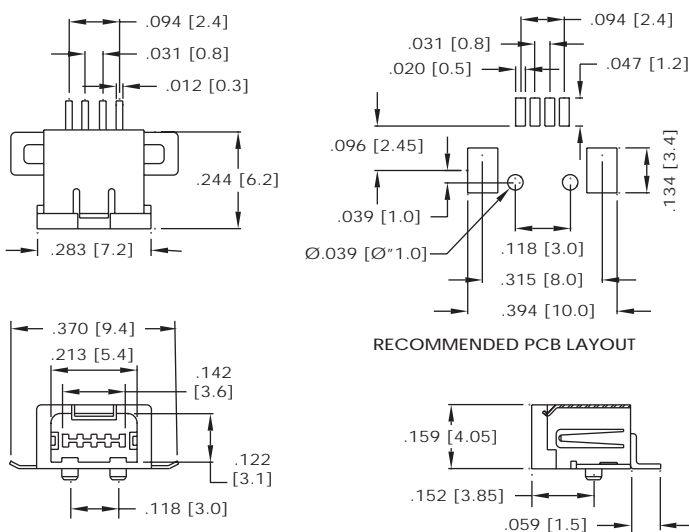

### USM-B5-1(5P) MINI-USB-B5 THROUGH HOLE

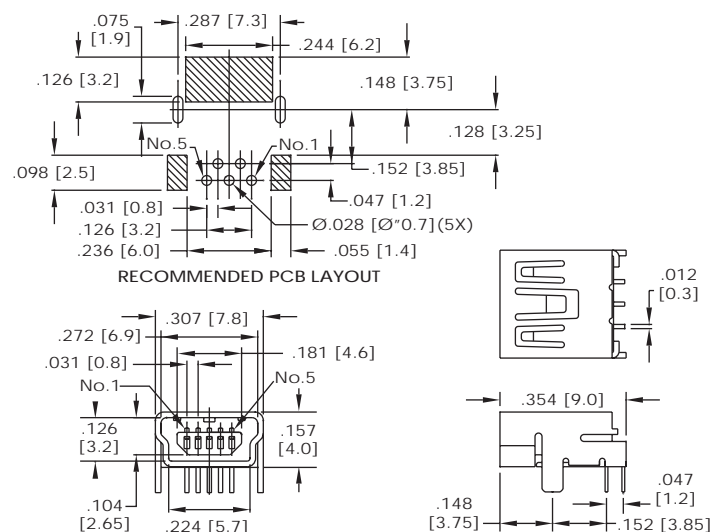

# USB AND IEEE 1394

UNIVERSAL SERIAL BUS & FIREWIRE CONNECTORS



## USB-A-1 SINGLE PORT THROUGH HOLE

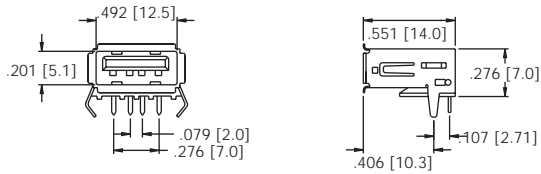

.6

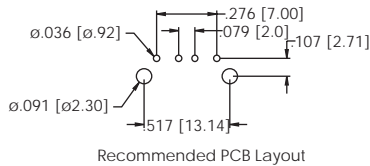

## USB-A-1-SMT SINGLE PORT SMT

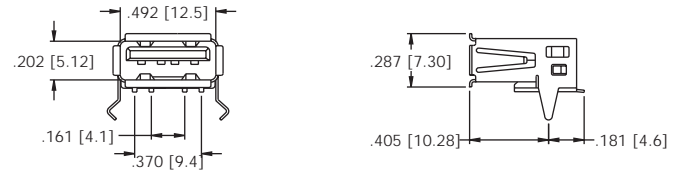
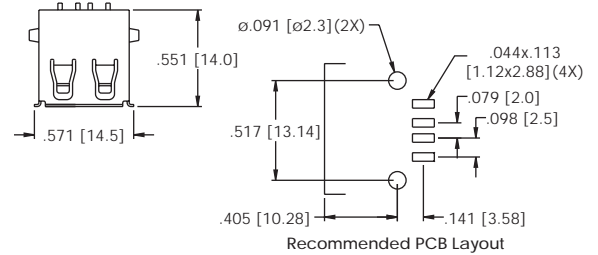

## USB-A-2 DUAL PORT THROUGH HOLE

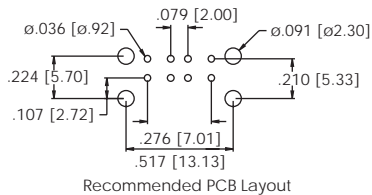
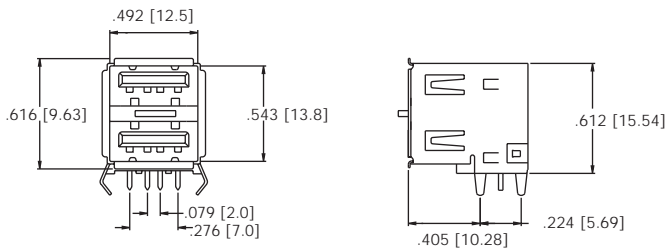

## FWC-C-1-UP FIREWIRE CONNECTOR

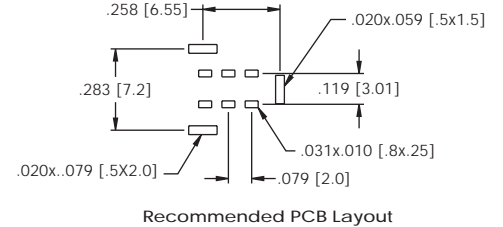
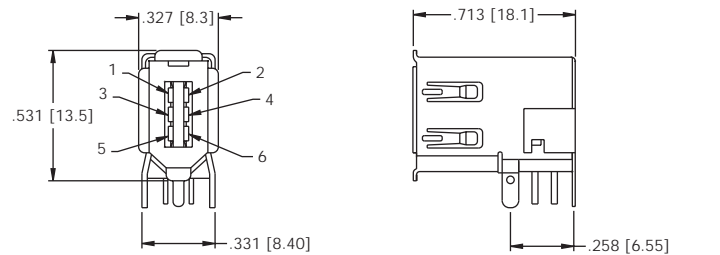

## USB-B-1 THROUGH HOLE

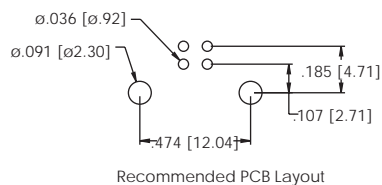
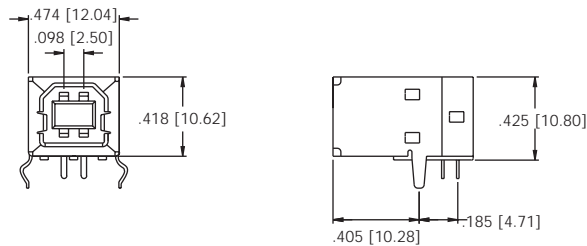

## FWC-C-1-SMT FIREWIRE CONNECTOR

