

EMI FILTERED AND SHIELDED JACKS

IMPEDANCE VS. FREQUENCY

Impedance Characteristic:

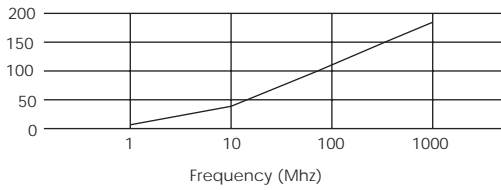

VALCONN offers a complete line of Telephone Jacks to meet most EMI requirements. Our Jacks are available with Tin Plated Copper Shielding with an Inductive Filter or Magnetic Capacitor Filter. These Jacks are available in Single Port, Ganged and Stacked versions. Their compact value added design offers your project a Lower Total Cost. They are invaluable for meeting stringent FCC/CISPR requirements.

- Meet FCC & CISPR
- Magnetic or Ferrite Option
- Broad Range of Filter Capability
- Large selection of Jacks to choose from

TYPE R EMI FERRITE FILTERED JACK 6P4C/6P6C/8P8C

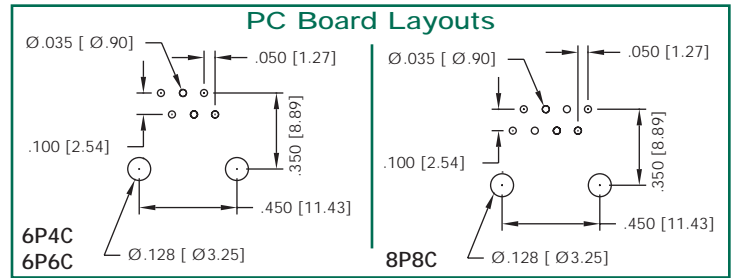
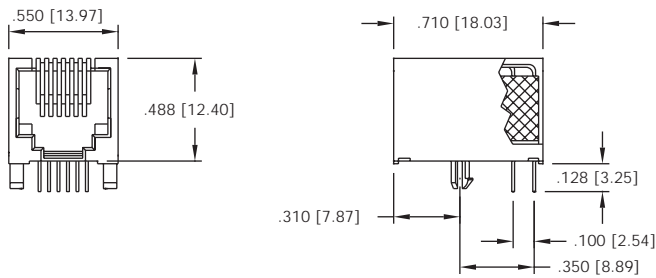

TYPE R EMI FERRITE FILTERED AND SHIELDED JACK 6P4C/6P6C/8P8C

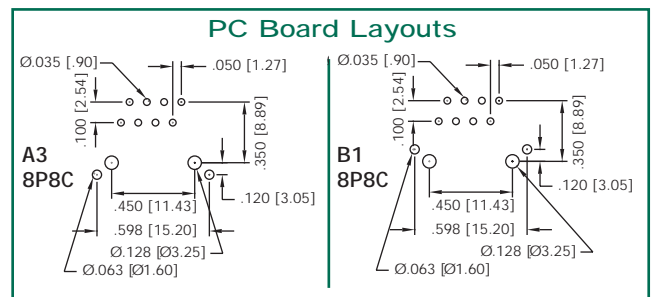
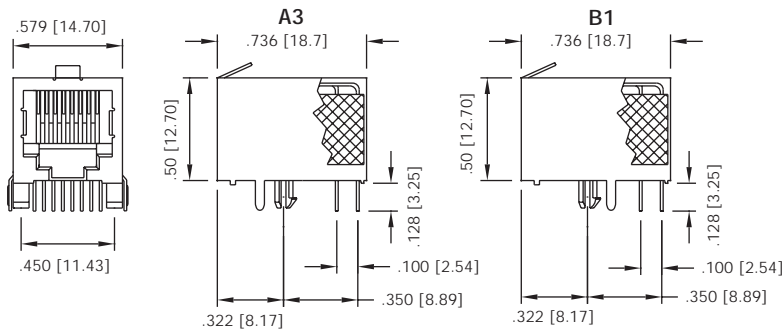

SHIELDING OPTIONS

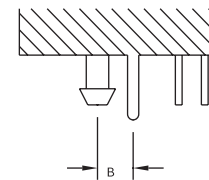
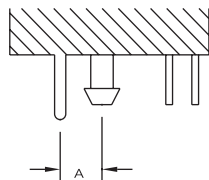

TYPE	DIMENSION A	BODY TYPE
A 1	.170" [4.32mm]	ALL
A 2	.144" [3.66mm]	ALL
A 3	.120" [3.05mm]	ALL
A 4	.180" [4.57mm]	ALL
A 5	.144" [3.66mm]	G
A 6	.456" [11.58mm]	Q

TYPE	DIMENSION B	BODY TYPE
B 1	.120" [3.05mm]	ALL
B 2	.140" [3.56mm]	ALL
B 3	.128" [3.25mm]	C, J
B 4	.150" [3.81mm]	F
B 5	.116" [2.95mm]	J